

TRASH BIN

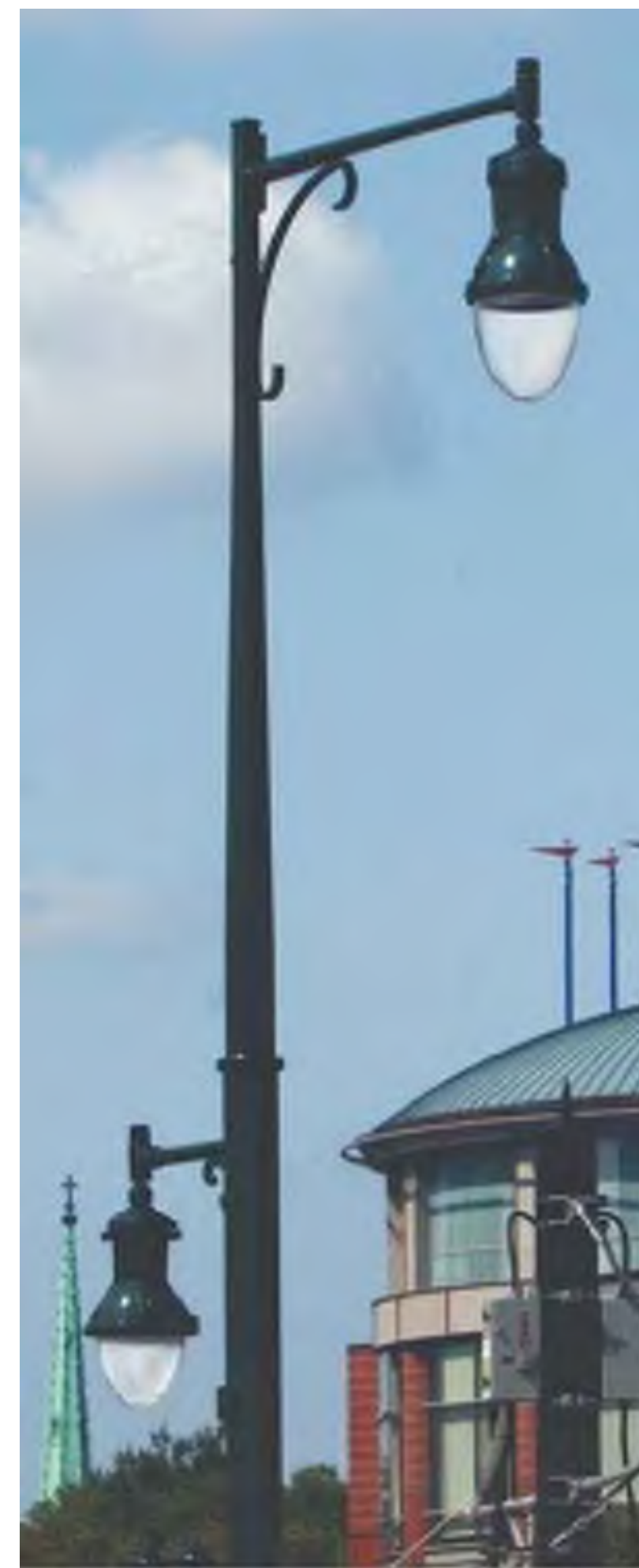

BIKE RACK

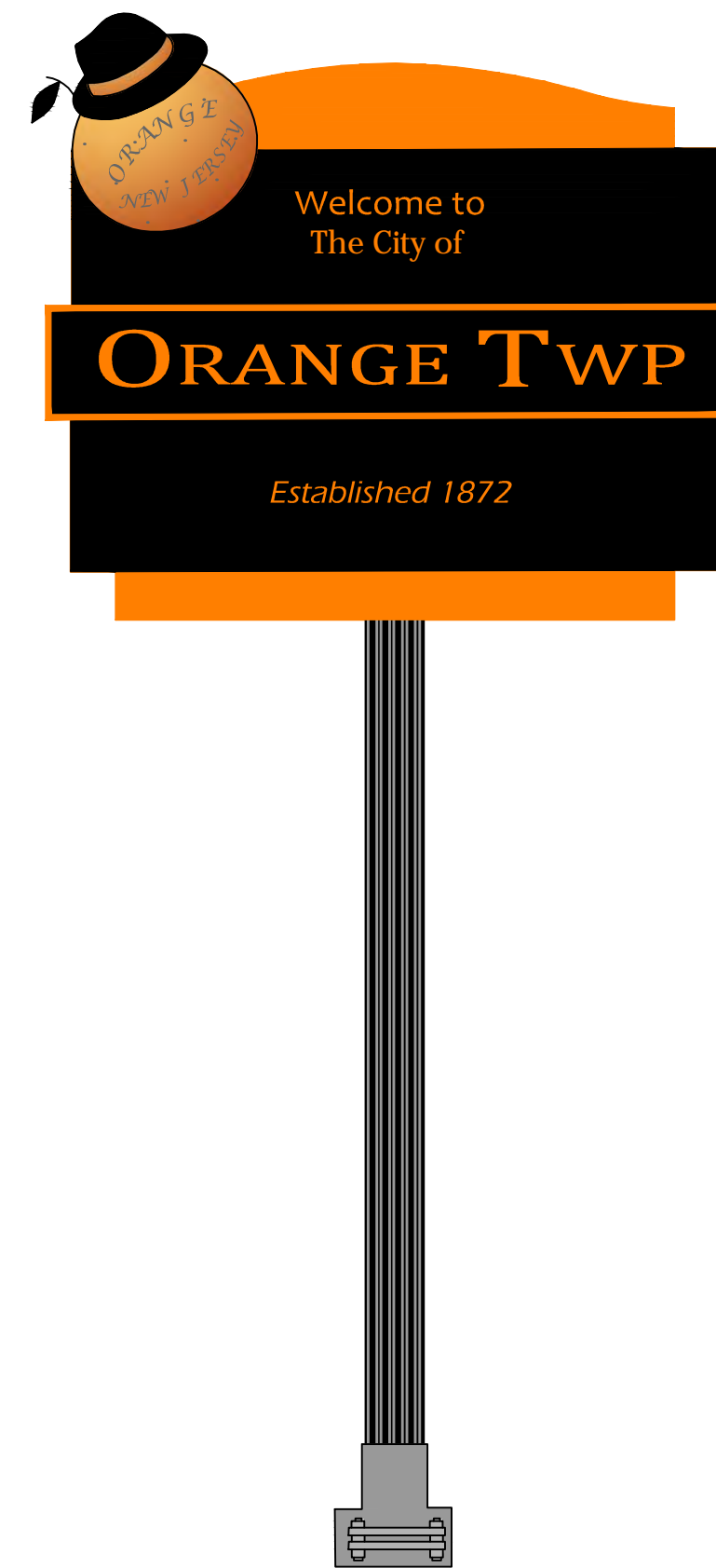
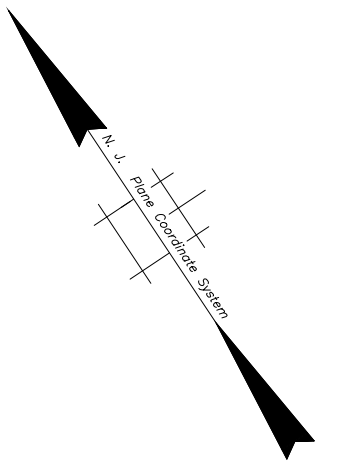

STREET LIGHTING

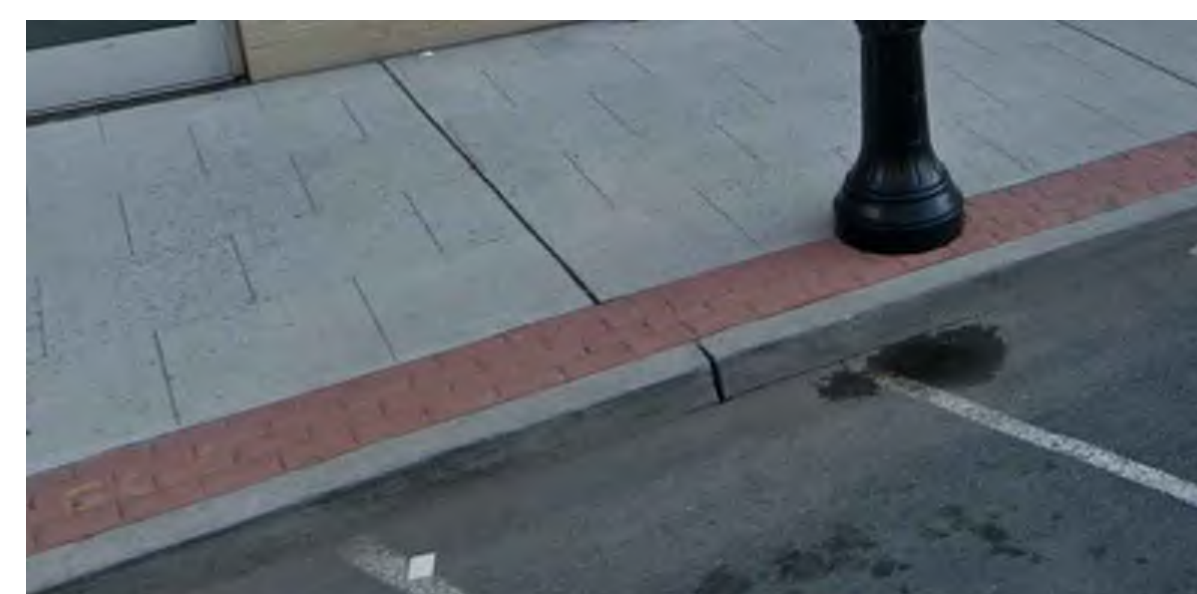

SCORED SIDEWALK WITH STAMPED BORDER



SCORED SIDEWALK

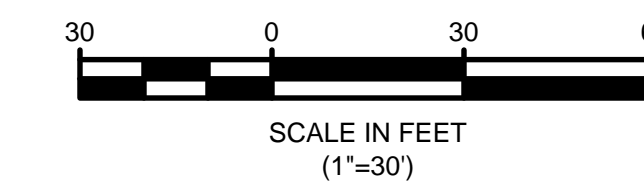

REVISIONS	BY	DATE

OVERALL IMPROVEMENT	
MAIN STREET STREETScape AND TRAFFIC CONTROL PROJECT MAIN STREET CITY OF ORANGE TOWNSHIP, ESSEX COUNTY, NJ	
<p>Bright View Engineering BRIGHT VIEW ENGINEERING, LLC. FRANK J. ROTONDA, P.E. NJ LIC. NO. 38306</p>	<p>DATE: AUGUST 2020</p> <p>SHEET 1 OF 6</p> <p>BRIGHT VIEW ENGINEERING, LLC 851 OLD MOUNT PLEASANT AVE, SUITE 100 LIVINGSTON, NJ 07039 BrightViewEngineering.com T: 973.228.0609 CERT. OF AUTH. No.: 24GA28283000</p>

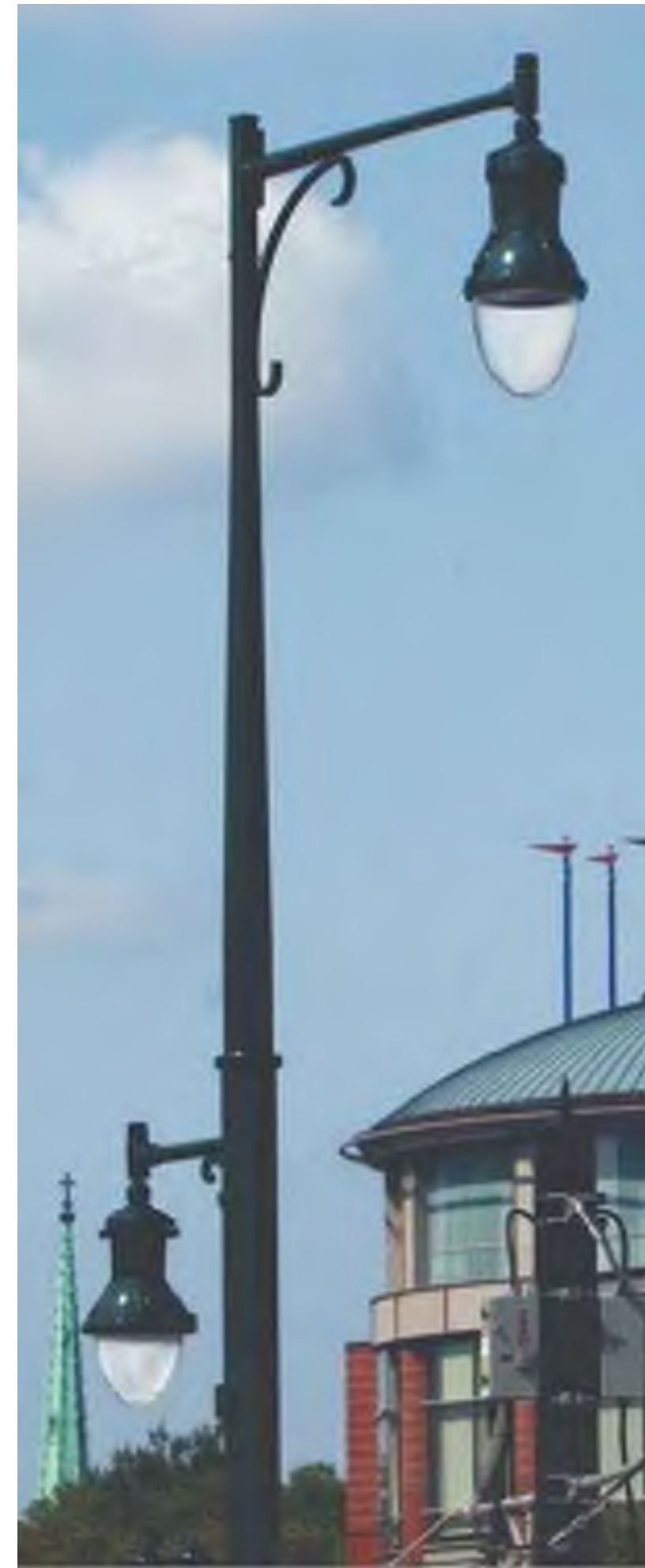

BLACK POWDER COATED SIGNALS



TRAFFIC CONTROLLER



IRON WROUGHT FENCING

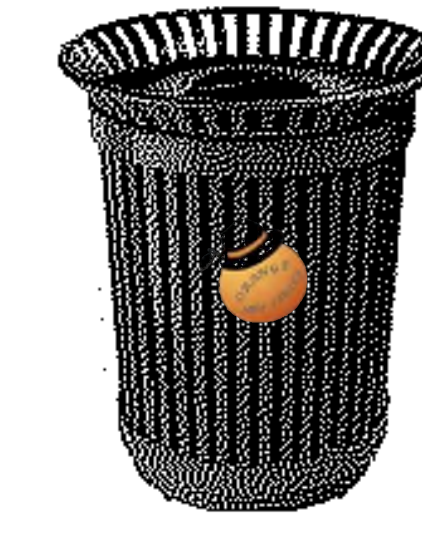

TRASH BIN

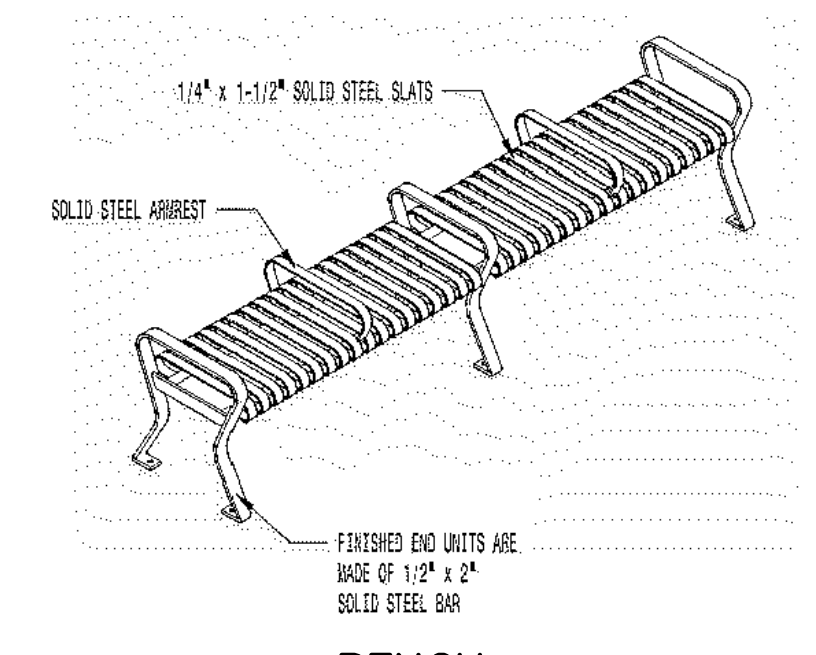

BENCH

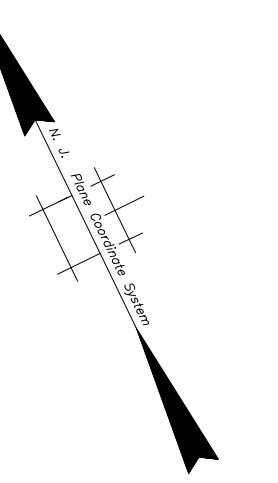

MATCH LINE A-A

MATCH LINE B-B

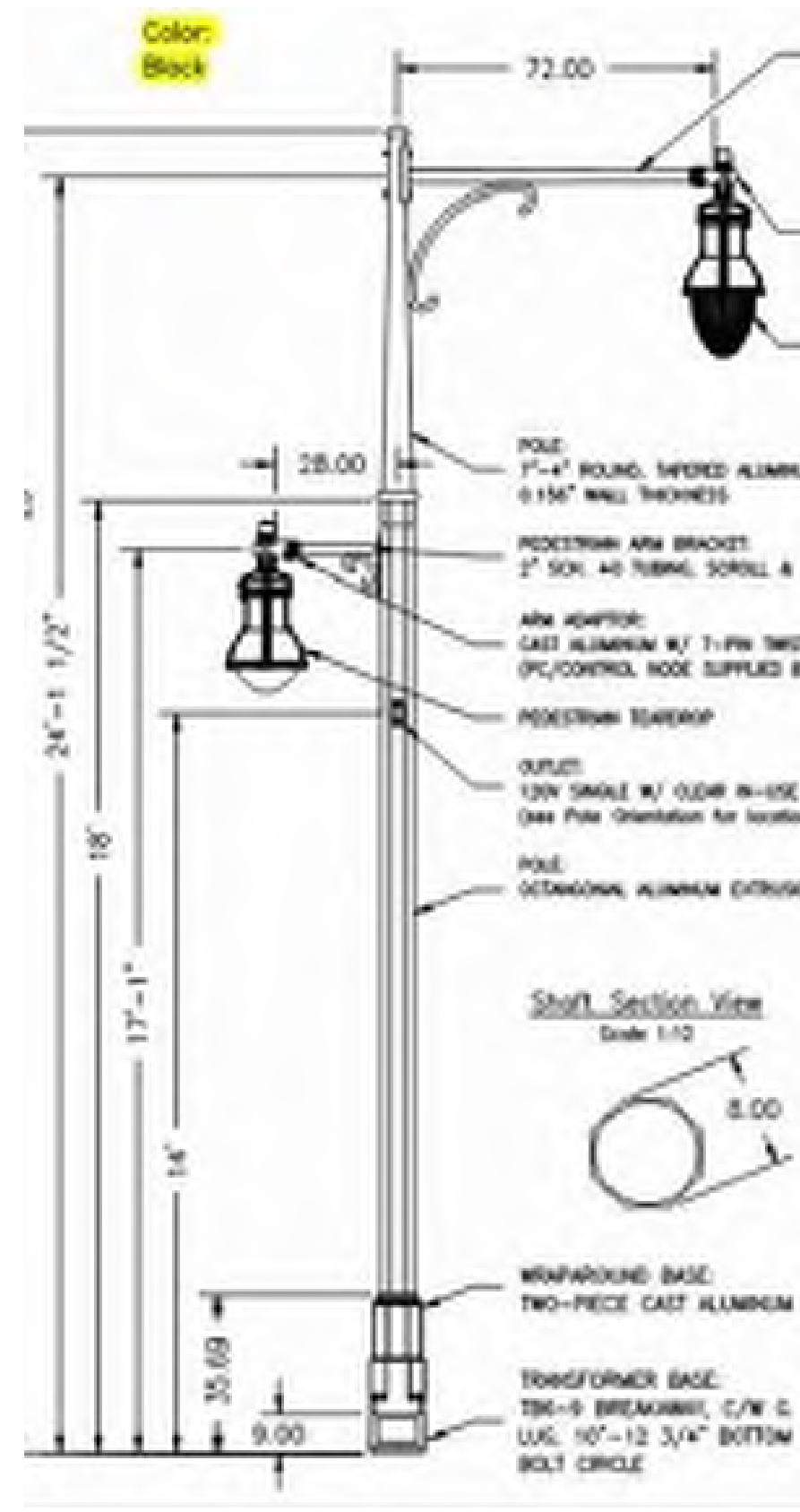

STREET LIGHTING



BIKE RACK

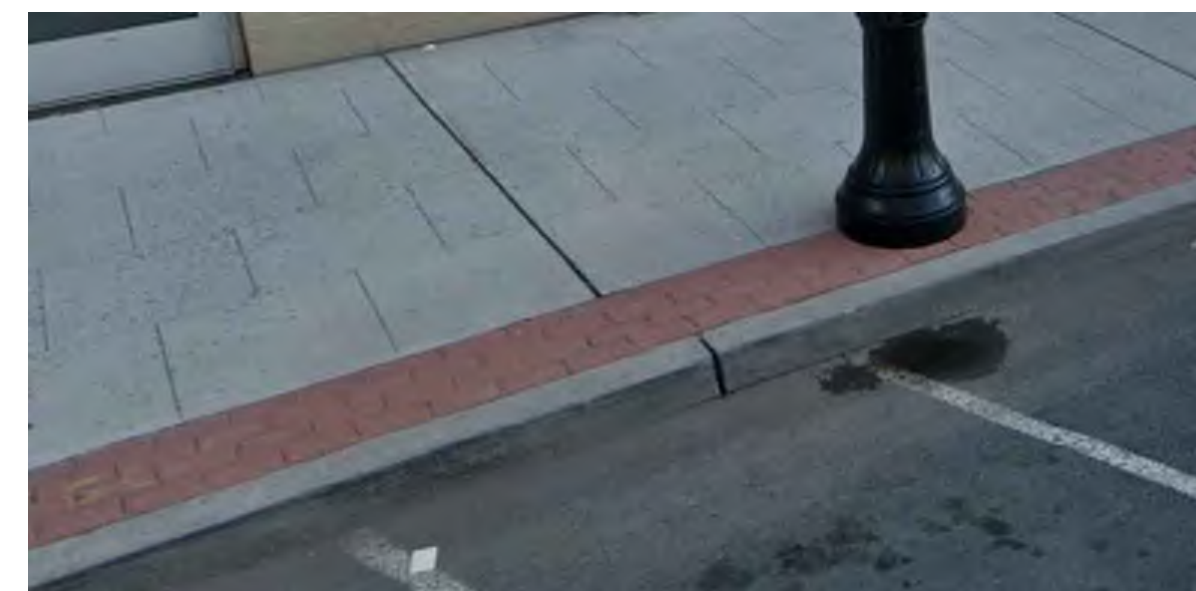

SCORED SIDEWALK WITH STAMPED BORDER



SCORED SIDEWALK

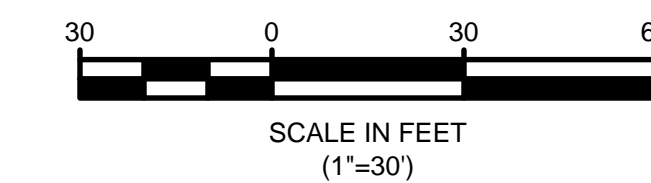

SCALE IN FEET
(1"=30')



OVERALL IMPROVEMENT	
MAIN STREET STREETScape AND TRAFFIC CONTROL PROJECT	
MAIN STREET	
CITY OF ORANGE TOWNSHIP, ESSEX COUNTY, NJ	
<p>Bright View Engineering Moving you forward</p>	<p>DESIGNED BY: GP/LLJ CHECKED BY: GP/LLJ DRAWN BY: RP SCALE: 1" = 30' DATE: AUGUST 2020</p>
DRAWING NO. 208101	SHEET 2 OF 6
BRIGHT VIEW ENGINEERING, LLC 851 OLD MOUNT PLEASANT AVE, SUITE 100 LIVINGSTON, NJ 07039 BrightViewEngineering.com T: 973.228.0909 CERT. OF AUTH. No.: 24GA28283000	
FRANK J. ROTONDA, P.E. NJ LIC. NO. 38306	DATE

REVISIONS	BY	DATE

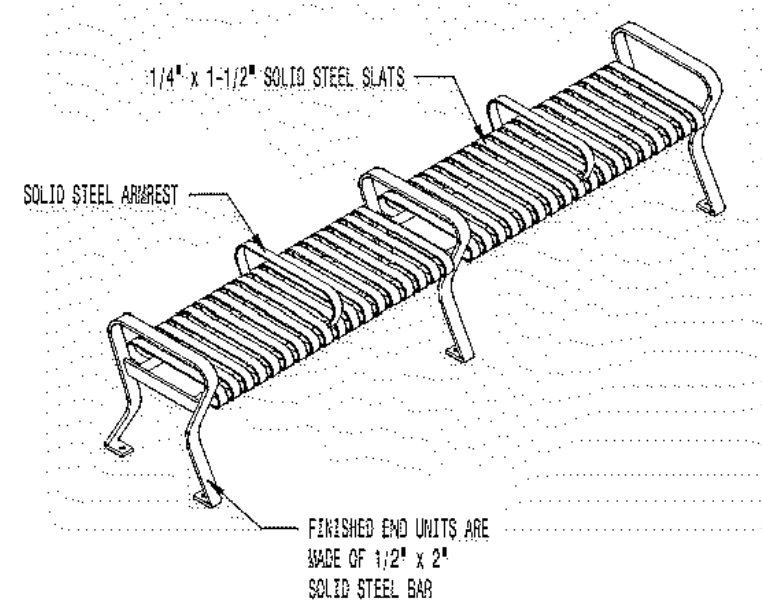

BENCH

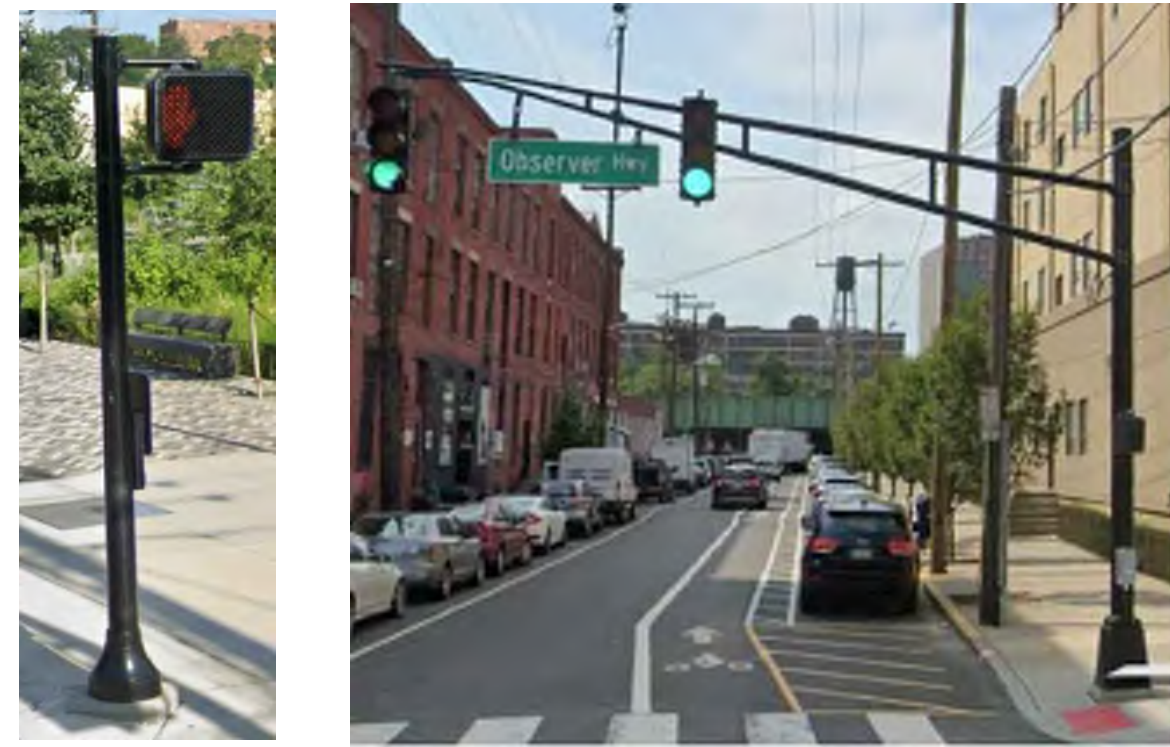

BLACK POWDER COATED SIGNALS



TRAFFIC CONTROLLER



IRON WROUGHT FENCING



TRASH BIN

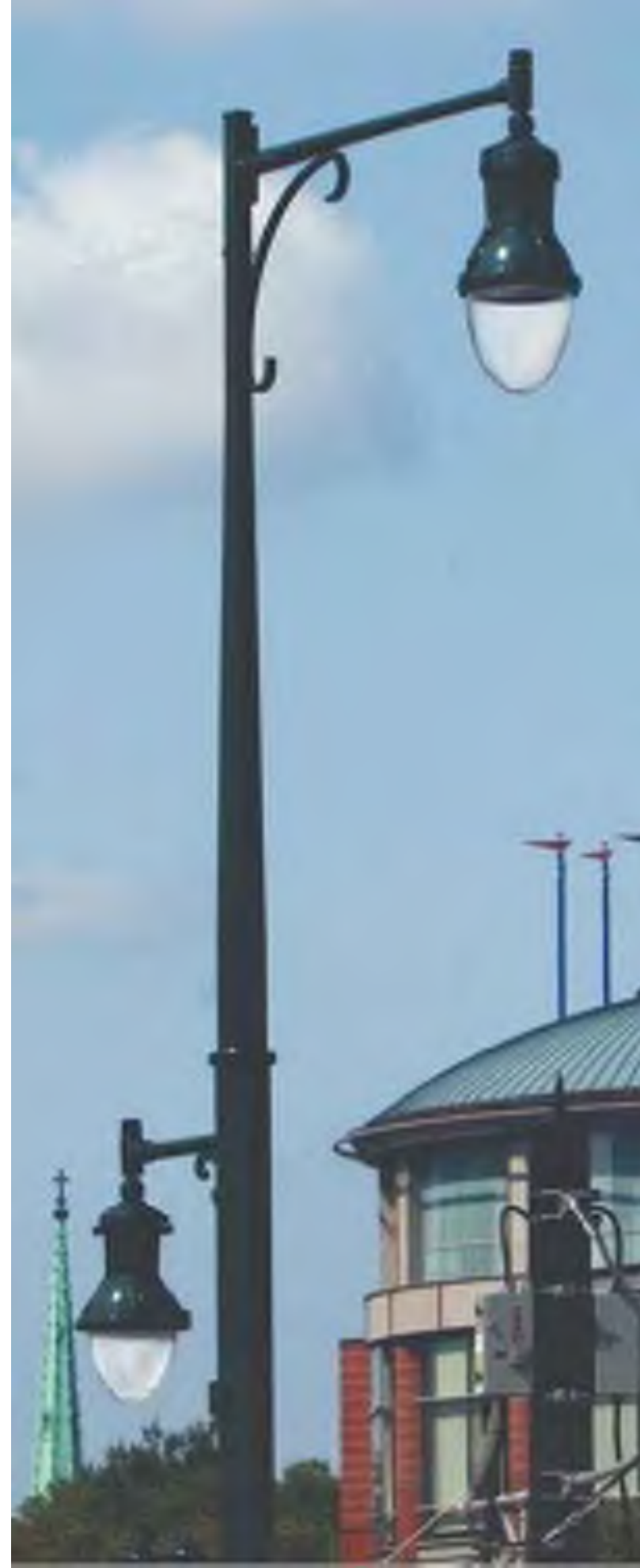
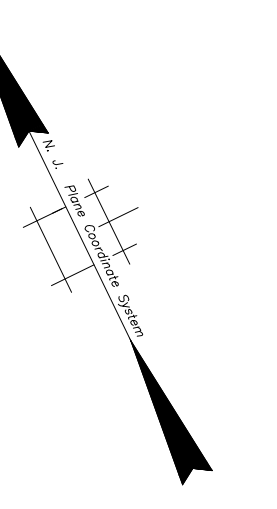

STREET LIGHTING

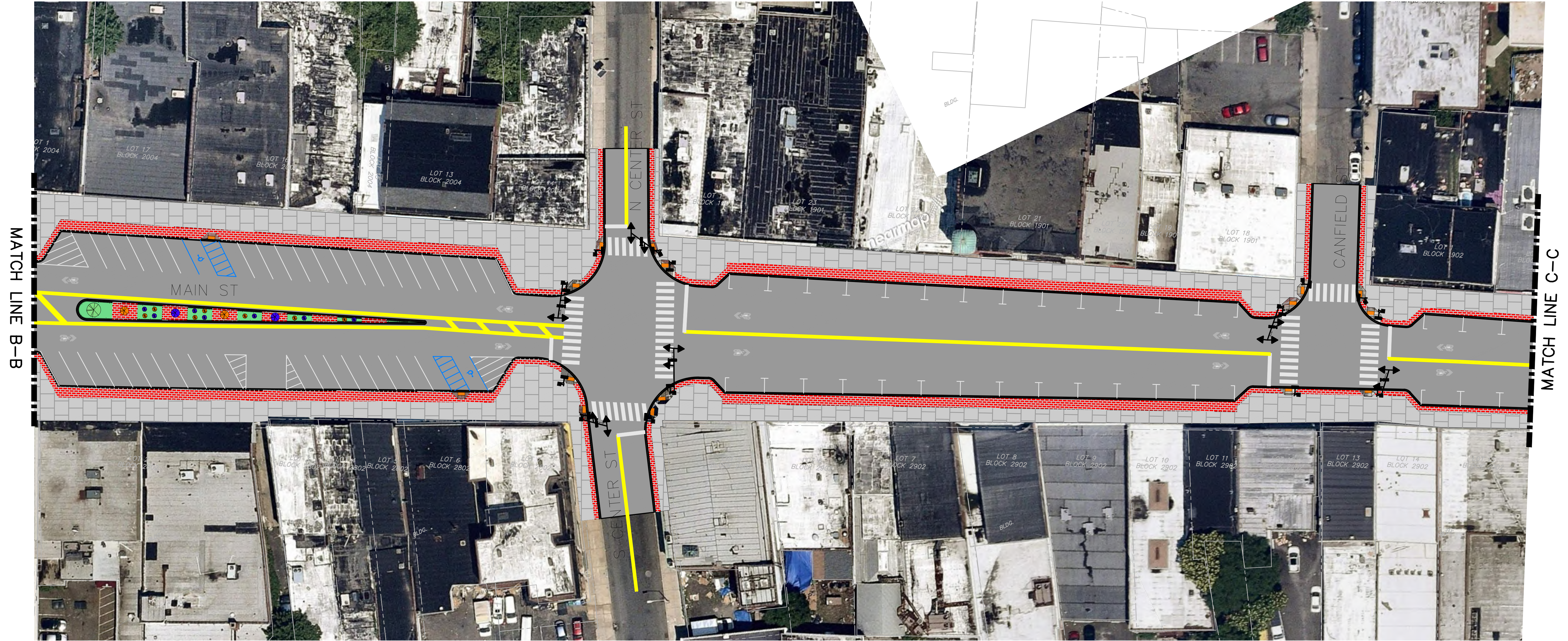

BIKE RACK

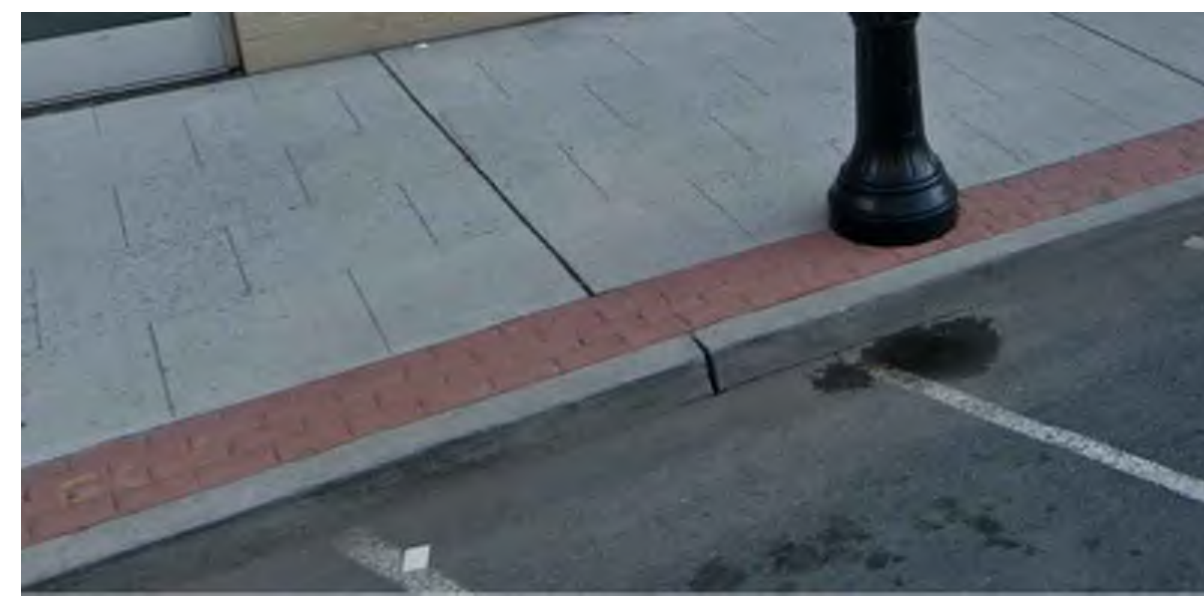

SCORED SIDEWALK WITH STAMPED BORDER



SCORED SIDEWALK

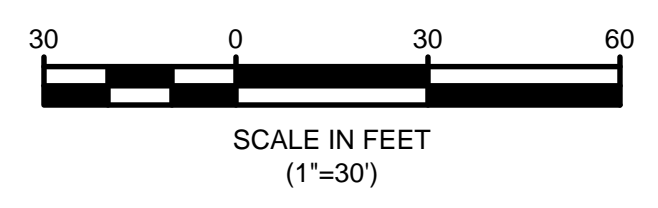

REVISIONS	BY	DATE



OVERALL IMPROVEMENT									
MAIN STREET STREETScape AND TRAFFIC CONTROL PROJECT MAIN STREET CITY OF ORANGE TOWNSHIP, ESSEX COUNTY, NJ									
<p>Bright View Engineering BRIGHT VIEW ENGINEERING, LLC 851 OLD MOUNT PLEASANT AVE, SUITE 100 LIVINGSTON, NJ 07039 BrightViewEngineering.com T: 973.228.0600 CERT. OF AUTH. No.: 24GA28283000</p>	<table border="1"> <tr> <td>DESIGNED BY</td> <td>06/11/20</td> </tr> <tr> <td>CHECKED BY</td> <td>06/11/20</td> </tr> <tr> <td>SCALE</td> <td>1" = 30'</td> </tr> <tr> <td>DATE</td> <td>AUGUST 2020</td> </tr> </table> <p>DRAWING NO. 208101 SHEET 4 OF 6</p>	DESIGNED BY	06/11/20	CHECKED BY	06/11/20	SCALE	1" = 30'	DATE	AUGUST 2020
DESIGNED BY	06/11/20								
CHECKED BY	06/11/20								
SCALE	1" = 30'								
DATE	AUGUST 2020								



STREET LIGHTING



BLACK POWDER COATED SIGNALS



TRAFFIC CONTROLLER

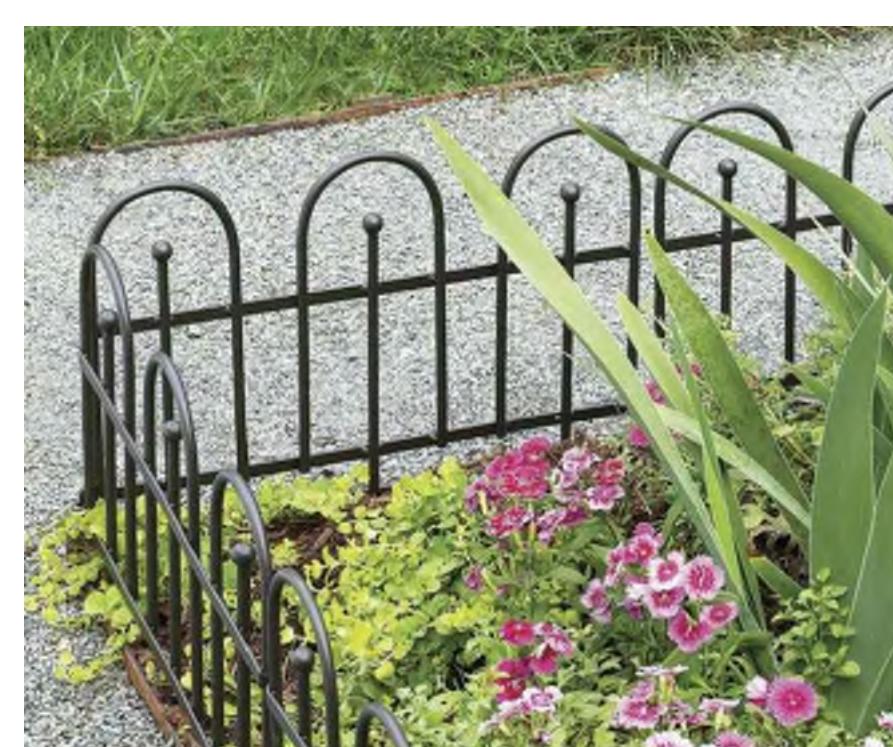

IRON WROUGHT FENCING

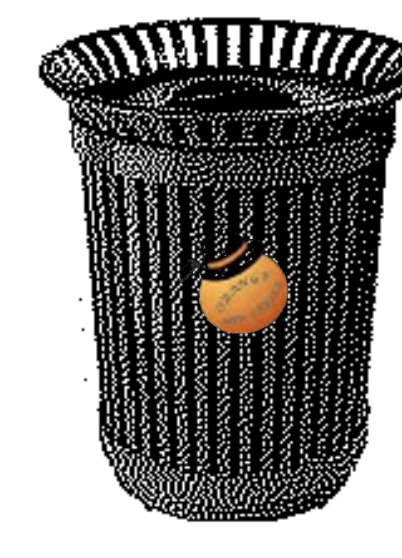

TRASH BIN

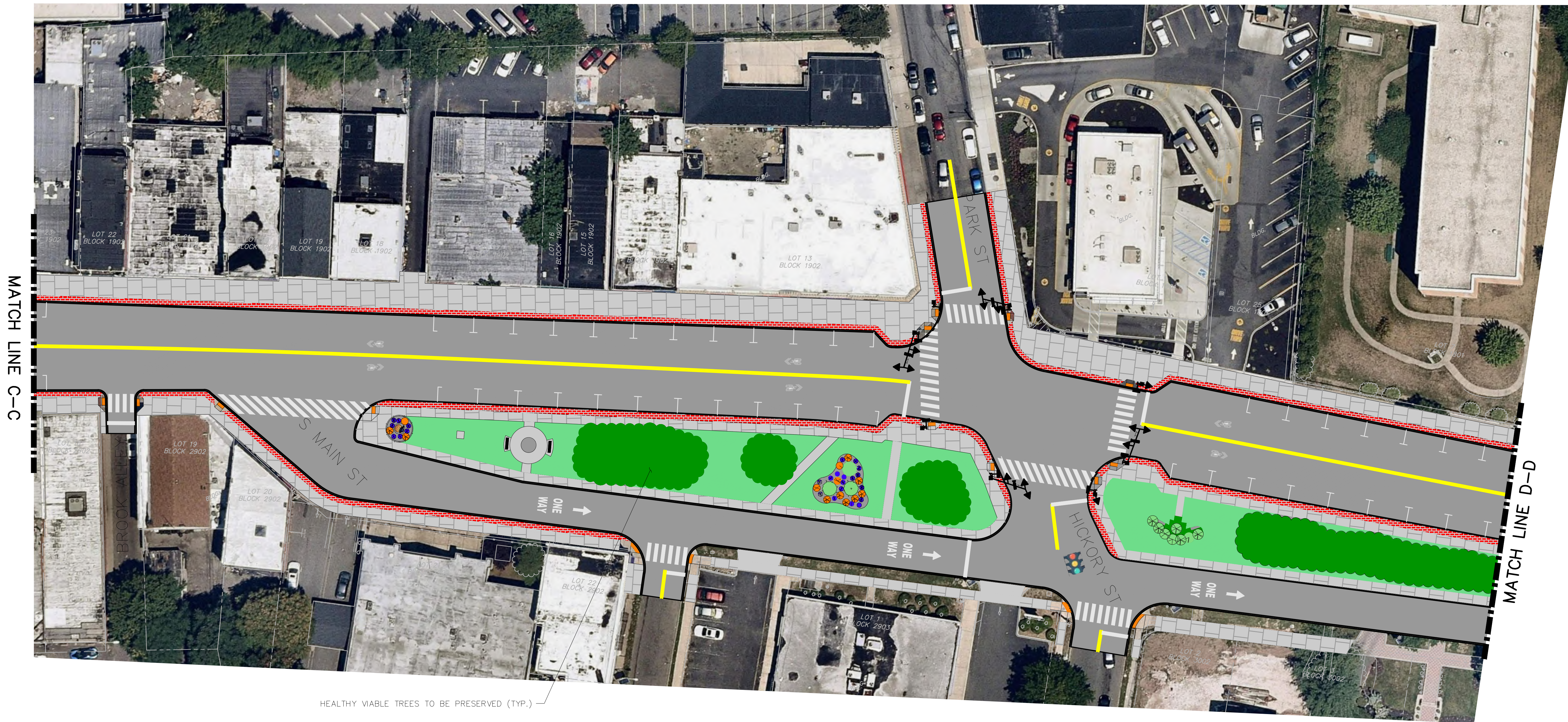
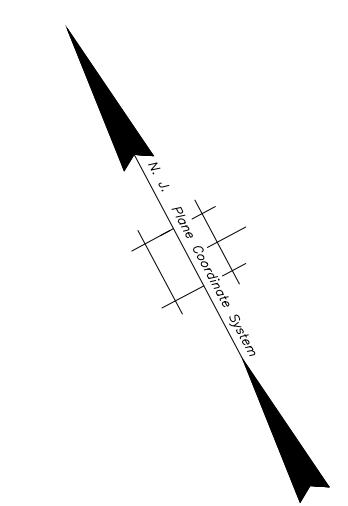

MATCH LINE C-C

MATCH LINE D-D

HEALTHY VIABLE TREES TO BE PRESERVED (TYP.)

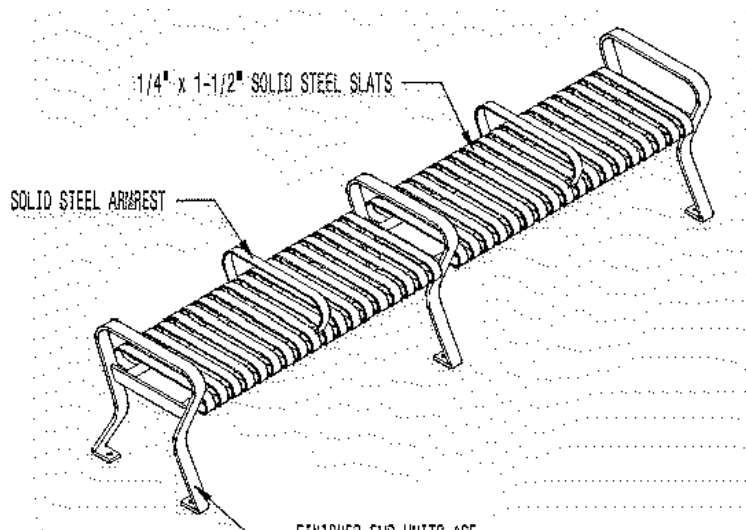

BENCH



BIKE RACK

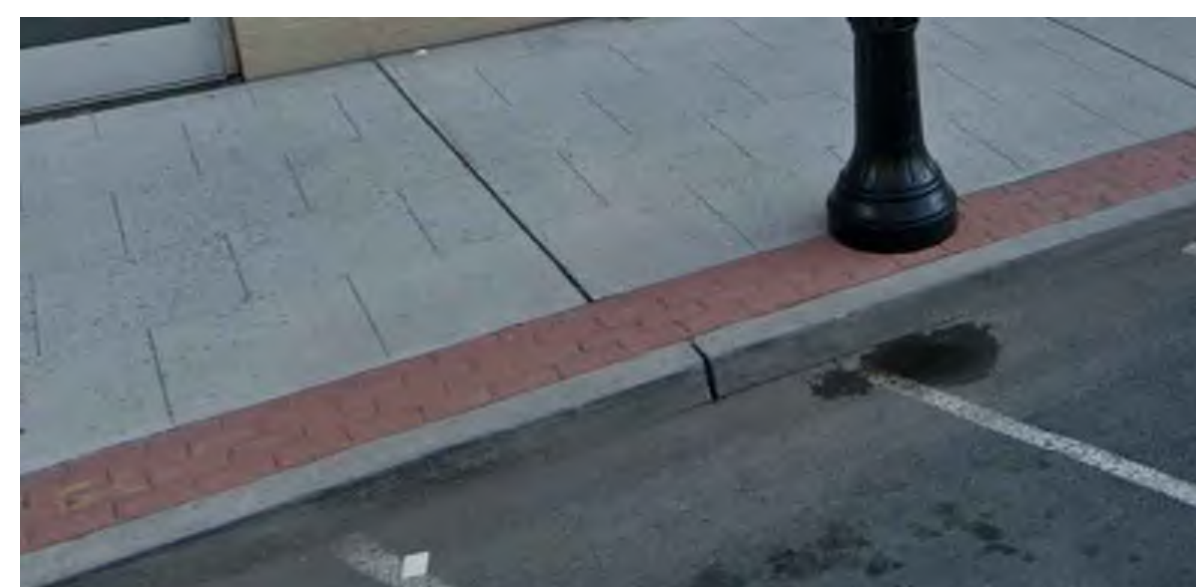

SCORED SIDEWALK WITH STAMPED BORDER



SCORED SIDEWALK

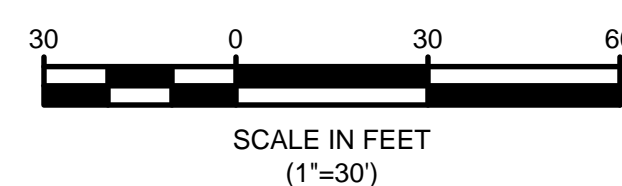

SCALE IN FEET
(1"=30')



REVISIONS	BY	DATE

OVERALL IMPROVEMENT	
MAIN STREET STREETScape AND TRAFFIC CONTROL PROJECT MAIN STREET CITY OF ORANGE TOWNSHIP, ESSEX COUNTY, NJ	
<p>Bright View Engineering Bright View Engineering, LLC 851 OLD MOUNT PLEASANT AVE, SUITE 100 LIVINGSTON, NJ 07039 BrightViewEngineering.com T: 973.228.0909 CERT. OF AUTH. No.: 24GA28283000</p>	<p>DESIGNED BY: GP/LLJ CHECKED BY: GP/LLJ DRAWN BY: RP DATE: AUGUST 2020 SCALE: 1" = 30'</p> <p>SHEET 4 OF 6</p>
<p>DRAWING NO. 208101 FRANK J. ROTONDA, P.E. NJ LIC. NO. 38306</p>	<p>DATE</p>

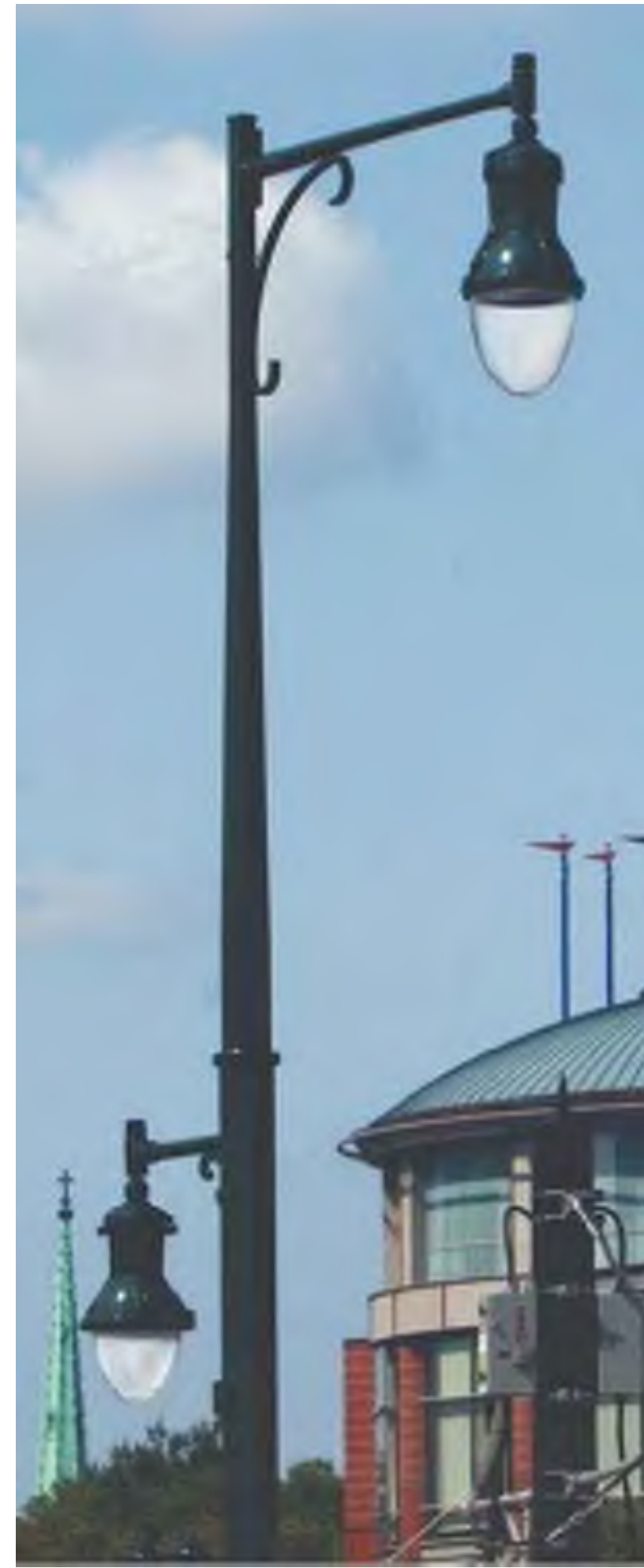

STREET LIGHTING



BLACK POWDER COATED SIGNALS



TRAFFIC CONTROLLER



IRON WROUGHT FENCING



TRASH BIN

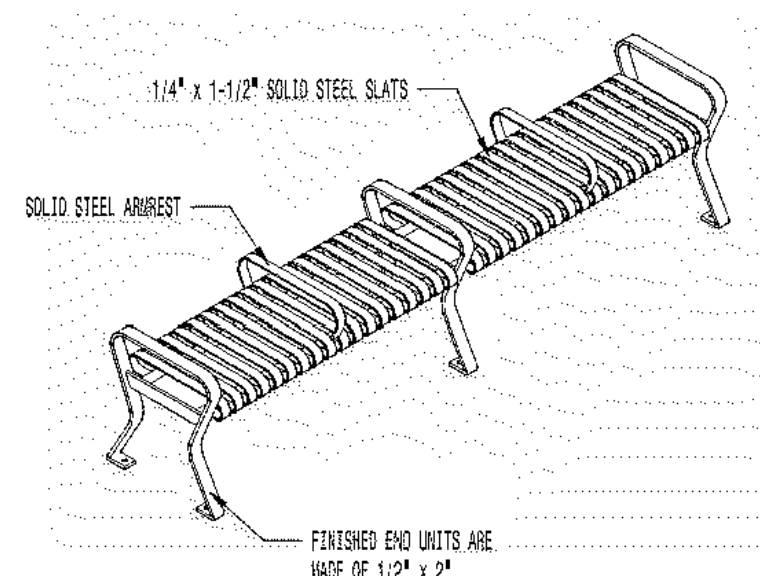
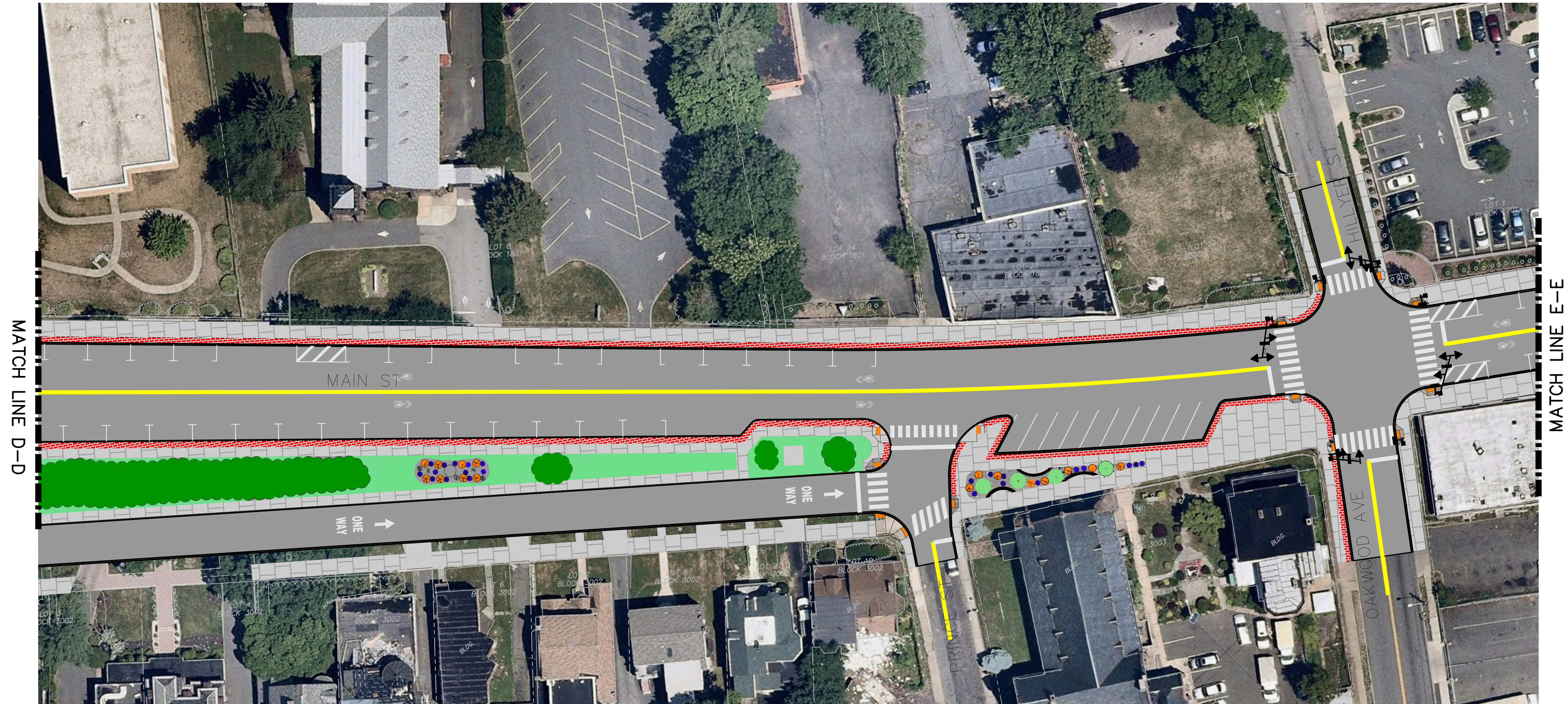
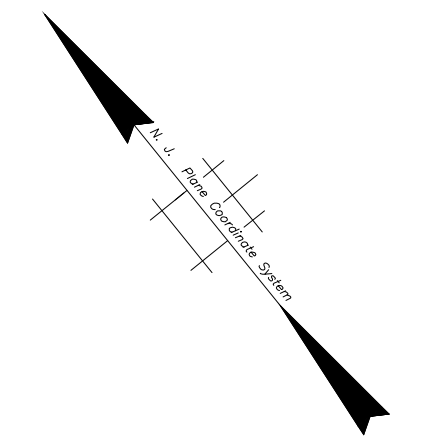

BENCH



BIKE RACK

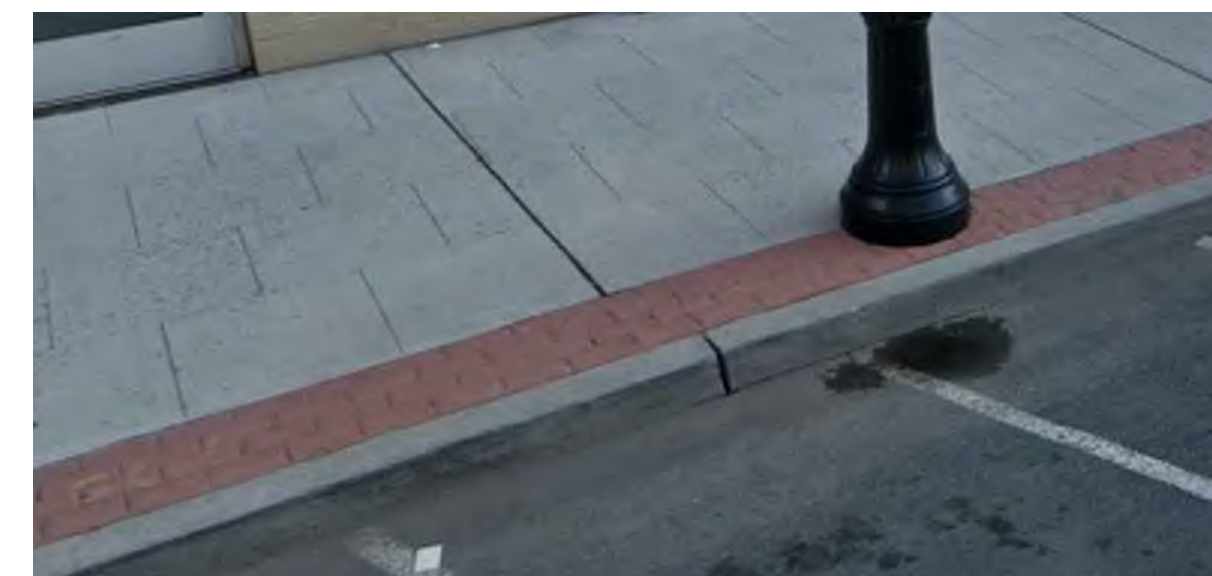

SCORED SIDEWALK WITH STAMPED BORDER



SCORED SIDEWALK

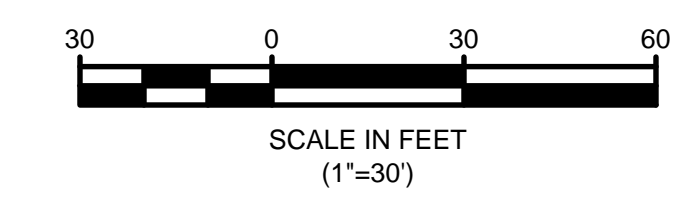

REVISIONS	BY	DATE

OVERALL IMPROVEMENT
 MAIN STREET STREETScape AND TRAFFIC CONTROL PROJECT
 MAIN STREET
 CITY OF ORANGE TOWNSHIP, ESSEX COUNTY, NJ

<p>Bright View Engineering BRIGHT VIEW ENGINEERING, LLC 851 OLD MOUNT PLEASANT AVE, SUITE 100 LIVINGSTON, NJ 07039 BrightViewEngineering.com T: 973.228.0909 CERT. OF AUTH. No.: 24GA28283000</p>	<p>DESIGNED BY: GP/LLJ CHECKED BY: RP SCALE: 1" = 30' DATE: AUGUST 2020</p>
	<p>DRAWING NO.: 208101 SHEET 5 OF 6</p>

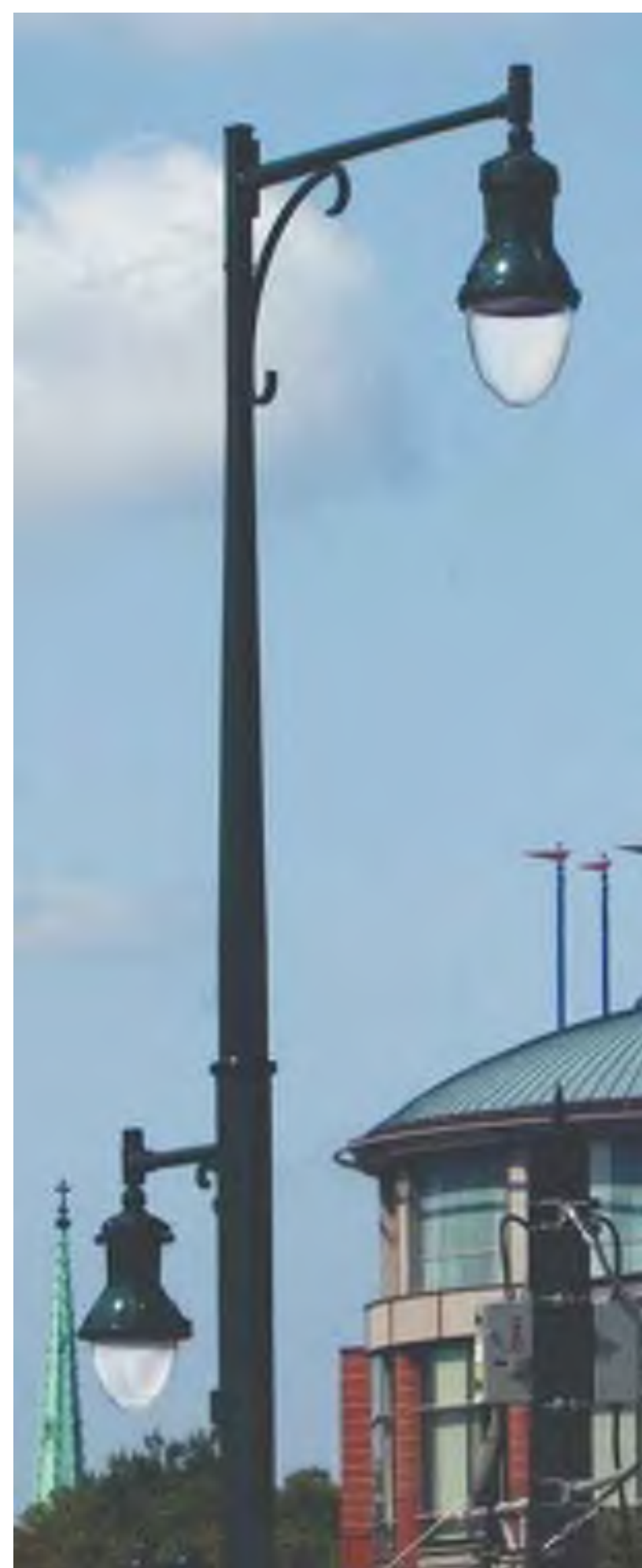
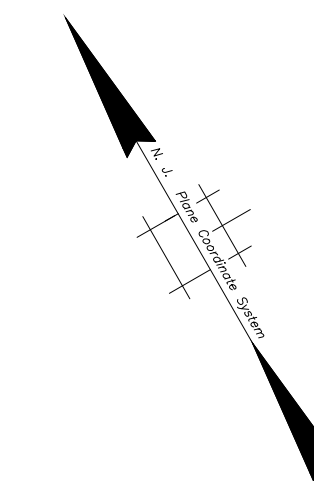

STREET LIGHTING

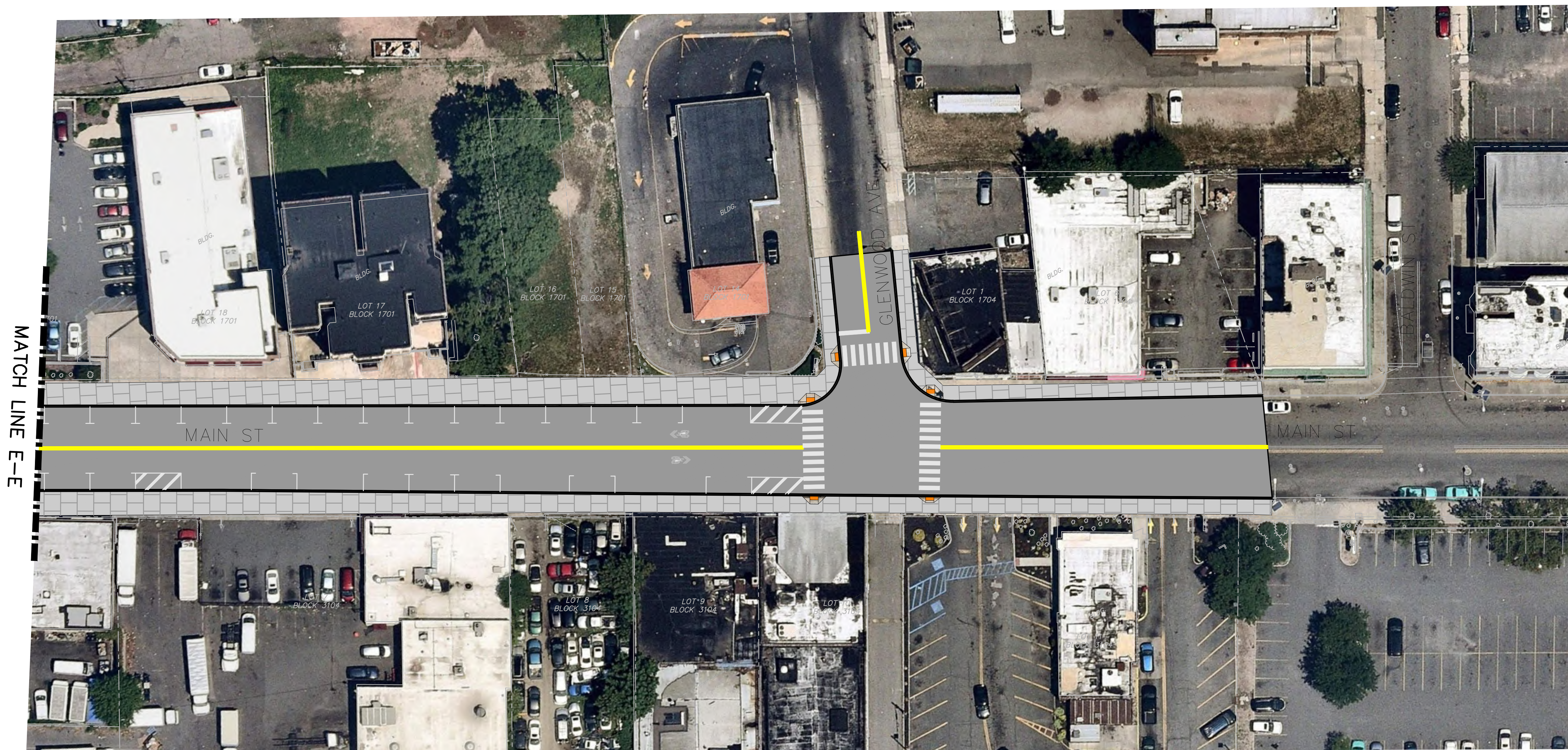

MATCH LINE E-E



BIKE RACK

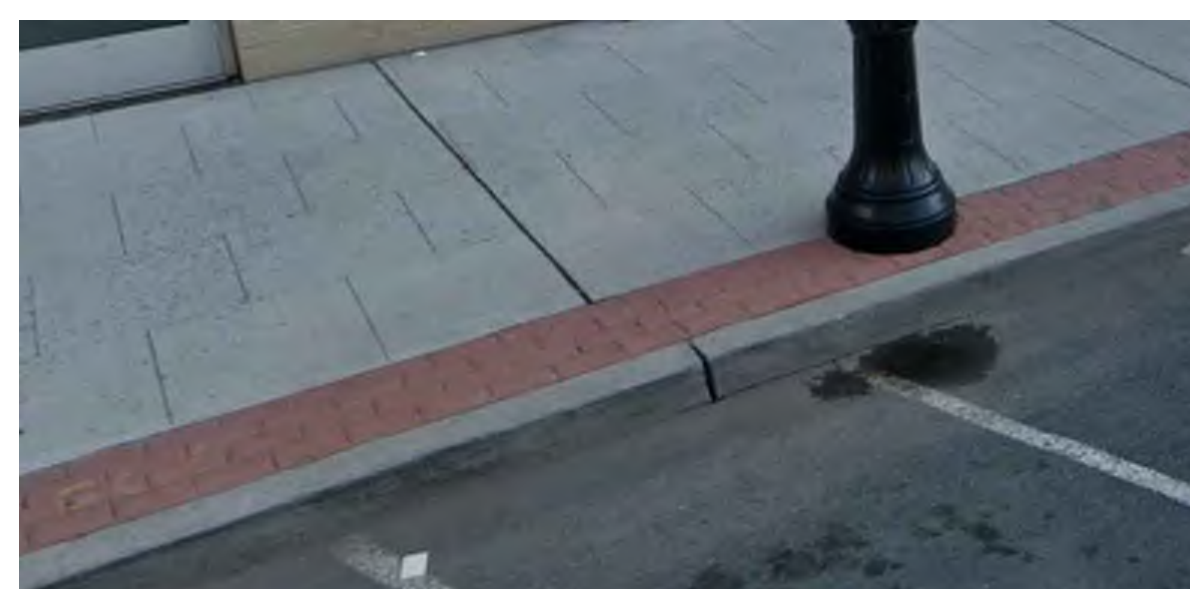

SCORED SIDEWALK WITH STAMPED BORDER



TRASH BIN

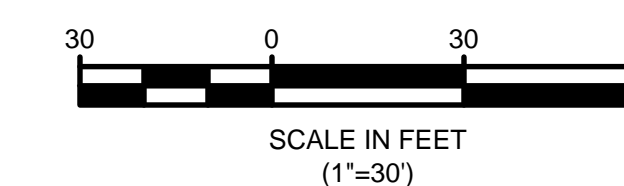

REVISIONS	BY	DATE

OVERALL IMPROVEMENT									
MAIN STREET STREETScape AND TRAFFIC CONTROL PROJECT MAIN STREET CITY OF ORANGE TOWNSHIP, ESSEX COUNTY, NJ									
<p>Bright View Engineering BRIGHT VIEW ENGINEERING, LLC 851 OLD MOUNT PLEASANT AVE, SUITE 100 LIVINGSTON, NJ 07039 BrightViewEngineering.com T: 973.228.0909</p>	<table border="1"> <tr> <td>SURVEYED BY</td> <td>GG/LLJ</td> </tr> <tr> <td>DESIGNED BY</td> <td>RP</td> </tr> <tr> <td>SCALE</td> <td>1" = 30'</td> </tr> <tr> <td>DATE</td> <td>AUGUST 2020</td> </tr> </table>	SURVEYED BY	GG/LLJ	DESIGNED BY	RP	SCALE	1" = 30'	DATE	AUGUST 2020
SURVEYED BY	GG/LLJ								
DESIGNED BY	RP								
SCALE	1" = 30'								
DATE	AUGUST 2020								
<p>DRAWING NO. 208101</p> <p>FRANK J. ROTONDA, P.E. NJ LIC. NO. 38306</p>	<p>SHEET 6 OF 6</p> <p>BRIGHT VIEW ENGINEERING, LLC 851 OLD MOUNT PLEASANT AVE, SUITE 100 LIVINGSTON, NJ 07039 BrightViewEngineering.com T: 973.228.0909 CERT. OF AUTH. No.: 24GA28283000</p>								

